

CAPACITIVE SENSORS

RECHNER
SENSORS



For all transactions, the newest version of the „General Conditions of Sale and Delivery for Products and Services of the Electrical Industry ZVEI“ shall apply, along with the supplementary conditions „extended reservation of proprietary rights“, together with the supplements listed on our order confirmations and/or invoices.

All specifications are subject to change without notice. Reprint, even in part, only with our consent.

© RECHNER Germany 11/2016 EN - Printed in EU, all rights reserved.

Edition November 2016

With publication of this catalogue all former printed catalogues about RECHNER capacitive proximity sensors of the EasyMount series are invalid.

All specifications are subject to change without notice. (11/2016)

**CAPACITIVE
SENSORS**

EasyMount

	Pages
General description	4
EasyMount round Ø30 ETW	5
EasyMount round Ø30 ETM	6
EasyMount square ETM	7
Accessories	8
List of products	9

All specifications are subject to change without notice. (11/2016)

Capacitive Sensors

- ✓ for level control of liquids
- ✓ for level control of bulk material
- ✓ for leakage detection
- ✓ for position control of objects ... and much more.

These small sensors have all that makes the handling and application easy for the user.

EasyMount



tics and is very small in size. It can be mounted in various ways. It can be glued in the desired position, fixed with a cable tie or it can be mounted with one of the holders from the range accessories.

The sensitivity- or sensing distance adjustment is almost made by itself, thanks to the EasyTeach function.

EasyTeach

The mounting is really simple. The sensor itself is featured with excellent technical characteristics

In the course of which it does not matter if the magnet is used or the version with EasyTeach by wire is the model

of choice. The steps one has to pass through are easy and quick to complete, so the user does not lose time from looking after his core business.

= Simply perfect

With the use of the newest production technologies the components of the sensors are embedded in the plastic body. They are watertight and operate wear-free. All sensors produced from RECHNER Sensors Germany are 100 % tested. The product marking is made with modern laser technology for everlasting identification and traceability.

IP68

Laser product marking

For further information about Rechner Sensors feel free to contact us or visit our web site under www.rechner-sensors.com.

100 % tested

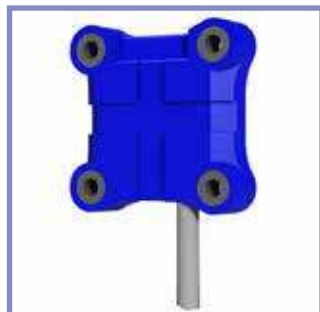
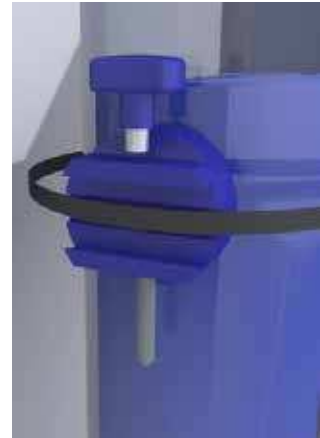

All specifications are subject to change without notice. (11/2016)



Capacitive Sensors

Series 70 - NPN **EasyMount**
Series 80 - PNP

Housing Ø 30 mm

- EasyTeach by wire
- Housing material: Polyamide (PA)
- Various mounting possibilities (see accessories)
- Capacitive sensor for level control of liquids or bulk material
- Capacitive sensor for detecting the position of objects
- Watertight



Technical data	Flush mountable	Flush mountable
Operating distance S_n	5 mm	5 mm
Operating distance min. / max. programmable	0...10 mm	0...10 mm
Electrical version	3 wire DC	3 wire DC
Output function	Normally open	Normally closed
Type NPN	KAS-70-30EM-S-PA-Z02-ETW-HP	KAS-70-30EM-Ö-PA-Z02-ETW-HP
Art.-No.	KA 1153	KA 1154
Connection diagram no.	1	2
Type PNP	KAS-80-30EM-S-PA-Z02-ETW-HP	KAS-80-30EM-Ö-PA-Z02-ETW-HP
Art.-No.	KA 1149	KA 1150
Connection diagram no.	3	4
Operating voltage (U_b)	10...35 V DC	10...35 V DC
Voltage drop max. (U_d)	≤ 2.0 V	≤ 2.0 V
Permitted residual ripple max.	10 %	10 %
Operating current (I_o)	0...200 mA	0...200 mA
No-load current (I_o)	Typ 15 mA	Typ. 15 mA
Frequency of operating cycles max.	2 Hz	2 Hz
Permitted ambient temperature	-25...+70 °C	-25...+70 °C
LED-display	Green / yellow	Green / yellow
Protective circuit	Built-in	Built-in
Degree of protection IEC 60529	IP 68	IP 68
Norm	EN 60947-5-2	EN 60947-5-2
Connection cable	2 m PVC, 4 x 0.14 mm ²	2 m PVC, 4 x 0.14 mm ²
Housing material	PA	PA
Accessory supplied with the sensor	-	-

All specifications are subject to change without notice. (11/2016)

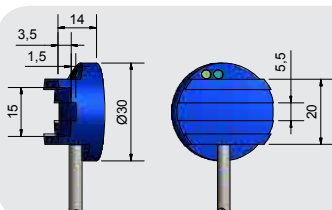
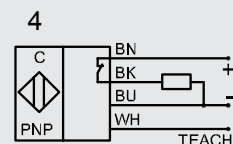
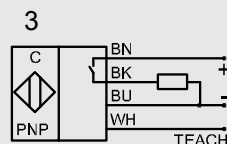
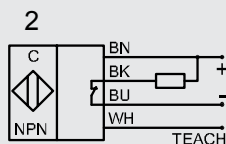
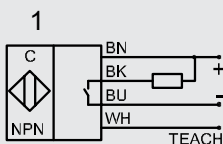

EasyTeach chart:
LED / Output function
Yellow = A1
Green = A1

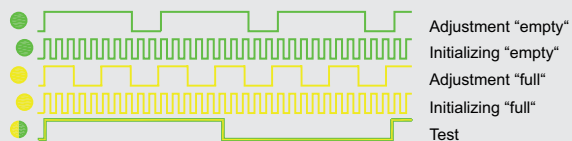

Made in Germany



Capacitive Sensors

Series 70 - NPN **EasyMount**
Series 80 - PNP

Housing Ø 30 mm

- EasyTeach by magnet (Magnet is supplied with the sensor)
- Housing material: Polyamid (PA)
- Various mounting possibilities (see accessories)
- Capacitive sensor for level control of liquids or bulk material
- Capacitive sensor for detecting the position of objects
- Watertight



Technical data	Flush mountable	Flush mountable
Operating distance S_n	5 mm	5 mm
Operating distance min. / max. programmable	0...10 mm	0...10 mm
Electrical version	3 wire DC	3 wire DC
Output function	Normally open	Normally closed
Type NPN	KAS-70-30EM-S-PA-Z02-ETM-HP	KAS-70-30EM-Ö-PA-Z02-ETM-HP
Art.-No.	KA 1151	KA 1152
Connection diagram no.	1	2
Type PNP	KAS-80-30EM-S-PA-Z02-ETM-HP	KAS-80-30EM-Ö-PA-Z02-ETM-HP
Art.-No.	KA 1147	KA 1148
Connection diagram no.	3	4
Operating voltage (U_B)	10...35 V DC	10...35 V DC
Voltage drop max. (U_o)	≤ 2.0 V	≤ 2.0 V
Permitted residual ripple max.	10 %	10 %
Operating current (I_o)	0...200 mA	0...200 mA
No-load current (I_o)	Typ 15 mA	Typ. 15 mA
Frequency of operating cycles max.	2 Hz	2 Hz
Permitted ambient temperature	-25...+70°C	-25...+70°C
LED-display	Green / yellow	Green / yellow
Protective circuit	Built-in	Built-in
Degree of protection IEC 60529	IP68	IP 68
Norm	EN 60947-5-2	EN 60947-5-2
Connection cable	2 m PVC, 3 x 0.14 mm ²	2 m PVC, 3 x 0.14 mm ²
Housing material	PA	PA
Accessory supplied with the sensor	Teach magnet	Teach magnet

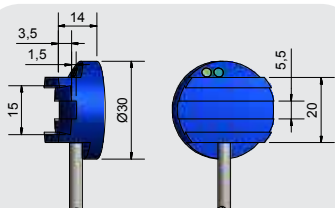
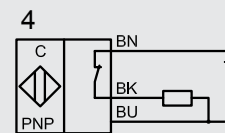
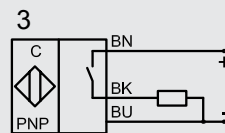
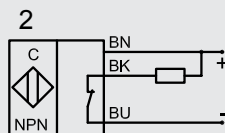
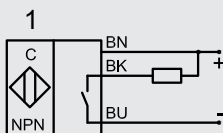

EasyTeach chart:
LED / Output function
Yellow = A1
Green = A1

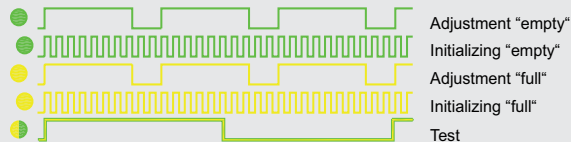

Made in Germany

All specifications are subject to change without notice. (11/2016)

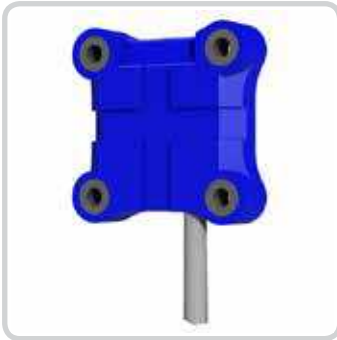

Capacitive Sensors Series 80 - PNP EasyMount

Housing 34 x 34 mm

- Housing material: PA / PVC
- Capacitive sensor for level control of liquids or bulk material
- Easy to mount, by screwing, glueing or with cable ties
- Watertight
- Sensitivity adjustment with EasyTeach by Magnet (ETM)
Magnet delivered with the sensor
- Flat housing - 8 mm
- Very suitable for a measurement through non-metallic container walls



Technical data	Flush mountable
Operating distance S_n	5 mm
Operating distance min. / max. programmable	0...10 mm
Electrical version	3 wire DC
Output function	Normally open
Type NPN	
Art.-No.	
Connection diagram no.	
Type PNP	KAS-80-C30EM/8-S-PA/PVC-Z02-ETM-HP
Art.-No.	KA 1451
Connection diagram no.	See below
Operating voltage (U_b)	10...35 V DC
Voltage drop max. (U_d)	≤ 2.0 V
Permitted residual ripple max.	10 %
Operating current (I_o)	0...200 mA
No-load current (I_o)	Typ 15 mA
Frequency of operating cycles max.	2 Hz
Permitted ambient temperature	-25...+70°C
LED-display	Green / yellow
Protective circuit	Built-in
Degree of protection IEC 60529	IP68
Norm	EN 60947-5-2
Connection cable	2 m PVC, 3 x 0.14 mm ²
Housing material	PA / PVC
Accessories (delivered with the sensor)	Teach magnet

All specifications are subject to change without notice. (11/2016)

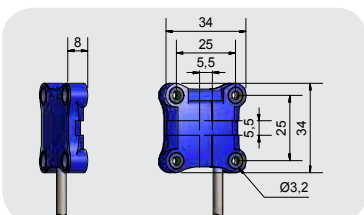
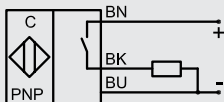



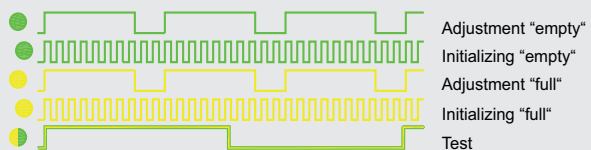



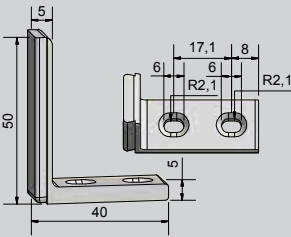

EasyTeach chart:
LED / Output function
Yellow = A1
Green = A1

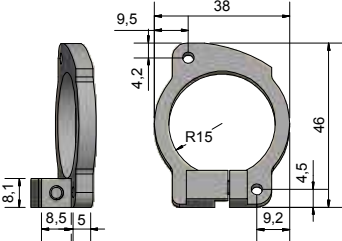

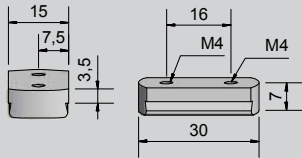
Made in Germany

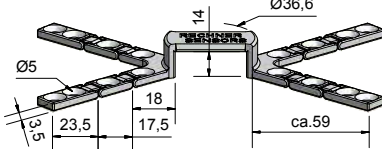
Accessories

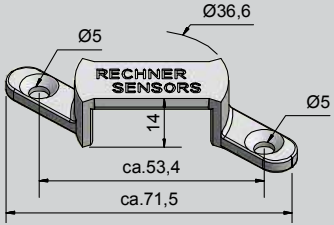
Picture	Art.-No.	Description	Dimensions
	196389	H-01 Angled holder Material PA 2200	
	196390	H-02 Mounting adapter Material PA 2200	
	196391	H-03 Mounting adapter Material PA 2200	
	196392	H-04 Mounting adapter foldable, e.g. for positioning of the sensor for leak control Material PA 2200	
	196393	H-05 Mounting adapter Material PA 2200	

All specifications are subject to change without notice. (11/2016)

TYPE SELECTION IN ARTICLE NUMBER ORDER

Art. No.	Description	Page
196389	EasyMount H-01	8
196390	EasyMount H-02	8
196391	EasyMount H-03	8
196392	EasyMount H-04	8
196393	EasyMount H-05	8
KA1147	KAS-80-30EM-S-PA-Z02-ETM-HP	6
KA1148	KAS-80-30EM-Ö-PA-Z02-ETM-HP	6
KA1149	KAS-80-30EM-S-PA-Z02-ETW-HP	5
KA1150	KAS-80-30EM-Ö-PA-Z02-ETW-HP	5
KA1151	KAS-70-30EM-S-PA-Z02-ETM-HP	6
KA1152	KAS-70-30EM-Ö-PA-Z02-ETM-HP	6
KA1153	KAS-70-30EM-S-PA-Z02-ETW-HP	5
KA1154	KAS-70-30EM-Ö-PA-Z02-ETW-HP	5
KA1451	KAS-80-C30EM/8-S-PA/PVC-Z02-ETM-HP	7

TYPE SELECTION IN DESCRIPTION ORDER

Description	Art. No.	Page
EasyMount H-01	196389	8
EasyMount H-02	196390	8
EasyMount H-03	196391	8
EasyMount H-04	196392	8
EasyMount H-05	196393	8
KAS-70-30EM-Ö-PA-Z02-ETM-HP	KA1152	6
KAS-70-30EM-Ö-PA-Z02-ETW-HP	KA1154	5
KAS-70-30EM-S-PA-Z02-ETM-HP	KA1151	6
KAS-70-30EM-S-PA-Z02-ETW-HP	KA1153	5
KAS-80-30EM-Ö-PA-Z02-ETM-HP	KA1148	6
KAS-80-30EM-Ö-PA-Z02-ETW-HP	KA1150	5
KAS-80-30EM-S-PA-Z02-ETM-HP	KA1147	6
KAS-80-30EM-S-PA-Z02-ETW-HP	KA1149	5
KAS-80-C30EM/8-S-PA/PVC-Z02-ETM-HP	KA1451	7

All specifications are subject to change without notice. (11/2016)

Customer proximity guaranteed!

Rechner Sensors has daughter and sister companies in China, Great Britain, Italy, Canada, South Korea and in the U.S..

Furthermore we have representative offices in over 50 countries. For the addresses of our sales partners please visit our website. You will find the addresses under the category contact.

CANADA

Rechner Automation Inc
348 Bronte St. South - Unit 11
Milton, ON L9T 5B6

Tel. 905 636 0866
Fax. 905 636 0867
contact@rechner.com
www.rechner.com

GREAT BRITAIN

Rechner (UK) Limited
Unit 6, The Old Mill
61 Reading Road
Pangbourne, Berks, RG8 7HY

Tel. +44 118 976 6450
Fax. +44 118 976 6451
info@rechner-sensors.co.uk
www.rechner-sensors.co.uk

ITALY

Rechner Italia SRL
Via Isarco 3
39100 Bolzano (BZ)
Office:
Via Guelfa 5
40138 Bologna
Tel. +39 051 0015498
Fax. +39 051 0015497
info@rechneritalia.it
www.rechneritalia.it

PEOPLE'S REPUBLIC OF CHINA

RECHNER SENSORS SIP CO.LTD.
Building H,
No. 58, Yang Dong Road
Suzhou Industrial Park
Jiangsu Province

Tel. +8651267242858
Fax. +8651267242868
assist@rechner-sensor.cn
www.rechner-sensor.cn

REPUBLIC OF KOREA (SOUTH)

Rechner-Korea Co. Ltd.
A-1408 Ho,
Keumgang Penterium IT Tower,
Hakeuiro 282, Dongan-gu
Anyang City, Gyunggi-do, Seoul

Tel. +82 31 422 8331
Fax. +82 31 423 83371
sensor@rechner.co.kr
www.rechner.co.kr

UNITED STATES OF AMERICA

Rechner Electronics Ind. Inc.
6311 Inducon Corporate Drive,
Suite 5
Sanborn, NY. 14132

Tel. 800 544 4106
Fax. 905 636 0867
contact@rechner.com
www.rechner.com



All specifications are subject to change without notice. (11/2016)

RECHNER

INDUSTRIE-ELEKTRONIK GMBH

Gaußstraße 8-10 • 68623 Lampertheim • Germany

T: +49 6206 5007-0 • F: +49 6206 5007-36 • F Intl. +49 6206 5007-20

www.rechner-sensors.com • E-mail: info@rechner-sensors.de