



Capacitive Sensors
Series 70 - NPN
Series 80 - PNP

- Housing M 32 x 1.5
- Housing material: PA / PPO
 - Sensing distance 2...30 mm adjustable
 - With flange connector M 12 x 1

Certificate:



Technical data	Non-flush mountable
Operating distance S_n	20 mm
Operating distance min. / max. adjustable	2...30 mm
Electrical version	4-pin DC
Output	Antivalent (NO+NC)
Type NPN	
Art.-No.	
Connection diagram No.	
Type PNP	KAS-80-35-A-M32-Y3-NL
Art.-No.	KA 0417
Connection diagram No.	6
Operating voltage (U_b)	12...30 V DC
Output current max. (I_o)	2 x 200 mA
Load current min.	-
Voltage drop max. (U_d)	≤ 2.0 V
Permitted residual ripple max.	5 %
No-load current (I_o)	< 15 mA
Frequency of operating cycles max.	50 Hz
Permitted ambient temperature	-25...+70 °C
LED-display	Yellow
Protective circuit	Built-in
Degree of protection IEC 60529	IP 67
Norm	EN 60947-5-2
Connection	Flange connector M 12 x 1
Housing material	PA / PPO
Active surface	PA / PPO
Lid	PA / PPO

All specifications are subject to change without notice. (27.01.2010)

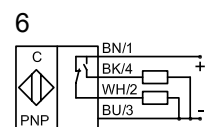
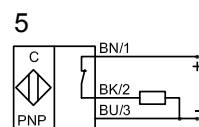
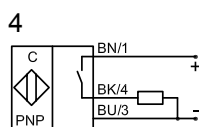
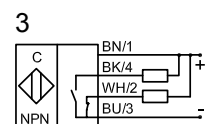
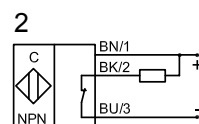
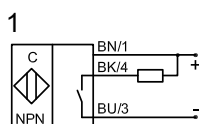
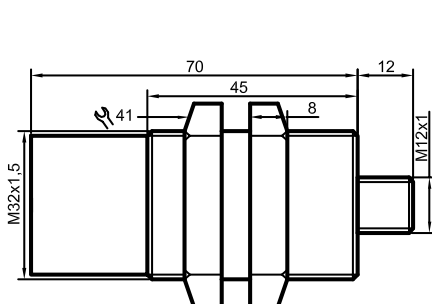

Made in Germany