

MAGNETO-RESISTIVE SENSORS

**RECHNER
SENSORS**





For all transactions, the newest version of the „General Conditions of Sale and Delivery for Products and Services of the Electrical Industry ZVEI“ shall apply, along with the supplementary conditions „extended reservation of proprietary rights“, together with the supplements listed on our order confirmations and/or invoices.

All specifications are subject to change without notice. Reprint, even in part, only with our consent.

© RECHNER Germany 02/2019 EN - Printed in EU, all rights reserved.

Edition February 2019

With publication of this catalogue all former printed catalogues about RECHNER magneto-resistive sensors are invalid.

All specifications are subject to change without notice. (20.02.2019)

TABLE OF CONTENTS

CATALOGUE MAGNETO-RESISTIVE SENSORS MRS

	Pages
Technology, mounting, application	4 - 6
Adjustment	6
Technical terms	7 - 8
Application examples	9
Type code	10 - 11
Types, technical data, dimensions, connection diagrams	13 - 21
Norms	22 - 23
Type selection in article number order	24
Type selection in description order	24

TECHNOLOGY • MOUNTING • APPLICATION

The magnetoresistive sensors (**MRS**) detect the movement of ferromagnetic materials, by means of the change of the magnetic flow. They are suitable for rotary speed sensing, for detection of gearwheels and for standstill control. Areas of use can be heavy construction engines, rail vehicles, large diesel engines and turbines.

The magnetoresistive sensors (MRS) work like a magnetic Wheatstone bridge. They react to all ferromagnetic materials. The tooth or gap of a gearwheel, when passing the active area of the sensor, influences the magnetic field. This results in a change of the magnet-field dependent resistor. This change of the magnetic field is transformed to an electrical voltage-bridge, which then is filtered and modified to a signal. The output signal is a voltage, which corresponds to the change in the magnetic field.

We have two different series:

⇒ Series 300	...-S	3-wire PNP or NPN
	...-N	2-wire
⇒ Series 350	...-S	4-wire PNP or NPN
	...-Z	4-wire PNP with dephased output signal with detection of direction of rotation

The components of the MRS are mounted in plastic or metal casings and encapsulated with epoxy casting resin.

The plastics used for the housings are:

- ⇒ PA (polyamide) 6.6 glass-fibre reinforced
- ⇒ PEEK (polyetheretherketone) (FDA 21 CFR 177.2415)

And the metal housings are

- ⇒ VA stainless-steel, material No. 4305 / AISI 303 or No. 4305 / AISI 316L (FDA conform).
- ⇒ MS brass / chrome or nickel-plated

Since the active area is made from a single block of material the degree of protection IP 68 is achieved on the front end.

Only pre-tested electronic components, proven integrated circuits and hybrid circuits are used and produced with SMT. The standard constant ambient temperature permitted is dependent on the model from -40 up to +125 °C (see data sheet).

With contactless detection no physical actuating force is required for operation. There is no contact bounce, no sensor wear, no maintenance and the service life is independent of the switching frequency.

MRS can be used in machines, systems and vehicles for contactless detection, for monitoring and positioning, as a pulse generator for counting tasks and speed measurements, and for many other applications (for application examples see page 9).

All specifications are subject to change without notice. (20.02.2019)

Wiring of the MRS should be routed separately or screened from heavy conductor lines, as in extreme cases inductive peak voltages can destroy the sensors despite the integrated protective circuit. Screened cable or twisted lines are recommended, especially for longer cable runs > 5 m. Direct control of electric light bulbs is to be avoided, because during the switch-on moment cold current is many times the rated current and can destroy the output stage of the sensor.

Units with strong local field power, e. g. high power walkie-talkies, or noise sources in the lower frequency range, e.g. long, middle or short wave transmitters should not be operated close to the sensors or additional measures have to be taken in order to eliminate false switching.

2- and 3-wire sensors with binary output can be used in series or parallel connection, similar to mechanical contacts. It is important to note the type-typical voltage drop and the residual voltage U_d , that must be multiplied, for series connection, in accordance with the number of sensors.

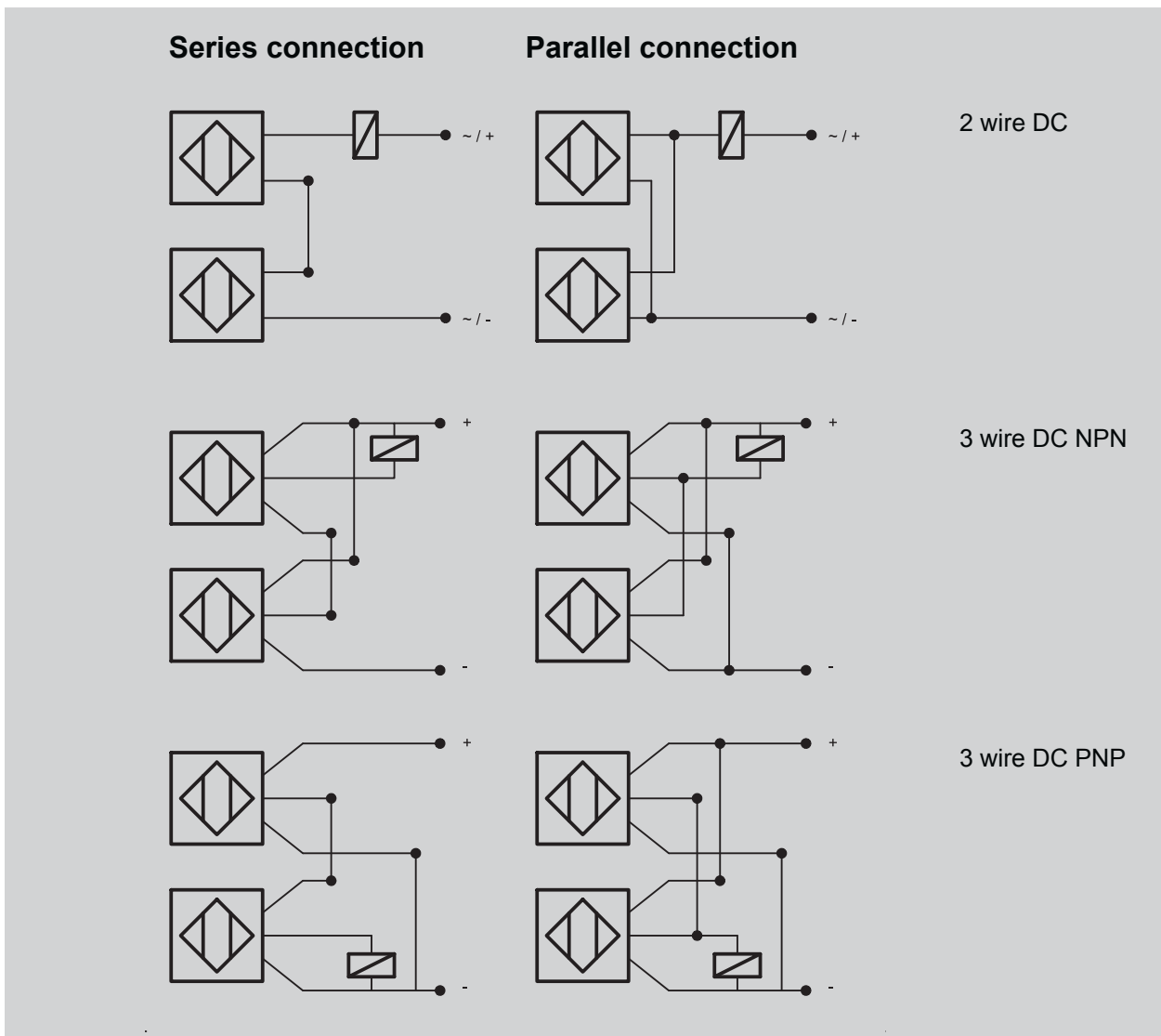

All specifications are subject to change without notice. (20.02.2019)

MAX. TORQUE

Thread	Housing material			
	PA 6.6	PPO	Brass	Stainless steel
M 12 x 1	1 Nm	1 Nm	15 Nm	15 Nm
M 18 x 1	1,7 Nm	1,7 Nm	28 Nm	40 Nm

The material and version-dependent maximum torque should be taken into consideration when mounting, in order to prevent damage to the threads. The values listed in the table are based on the use of the nuts supplied with the sensors.

MAX. SCREW-IN LENGTH

Thread:	M 12 x 1	M 18 x 1
Screw-in length	8 mm	12 mm

Due to the permitted thread tolerances specified in German standard DIN 13, the maximum screw-in length for threaded sensors should be taken into consideration. Depending on that the length of the threaded block for screwing in proximity sensors should not exceed the following dimensions. In the case of larger threaded blocks we recommend drilling a blind hole in order to adhere to the maximum screw-in length.

ADJUSTMENT

Speed sensing is possible with gearwheels from module 4 down to module 1 at a maximum switching frequency of 25 kHz. For detecting rotary speed / direction of rotation magneto-resistive sensors (MRS) must be mounted radially with respect to the direction of motion and with their marking set vertically to it. The dependence of the modul of the detected gearwheel on the mounting distance and the maximum detecting frequency is as follows:

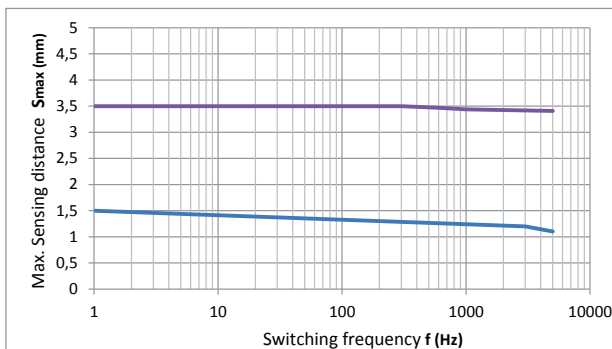

— Module 1
— Module 4

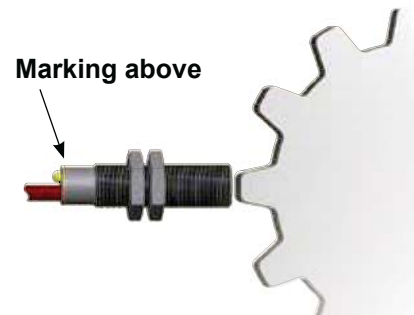

Example: MRS-300-M18-...

All specifications are subject to change without notice. (20.02.2019)

TECHNICAL TERMS

Unless otherwise specified technical data is as follows: +24 °C, $U_B = 24$ V DC.

Operating sensing distance / S_a

Within the operating sensing distance the sensor operates reliably taking in to account all the possible tolerances.

Power up time delay

The time the sensor needs to be ready for operation after connecting the operating voltage. It is in the milliseconds range.

Housing materials

The application of the housing materials used is based on the technical specifications of the material and of the manufacturer. The customer is responsible for checking in each case that the housing material is suitable for the application, even though RECHNER Sensors have far-reaching application experience concerning the use of different housing materials.

Cable

For the standard models PVC- or PUR-cable are used. One has to take into consideration that the cable should not be moved with ambient temperatures below -5 °C. PVC is not suitable for use in applications with oil-based liquids or with UV-radiation. PUR is not suitable for continuous contact with water. For special application areas silicone or PTFE cables are available.

Real sensing distance / S_r

The sensing distance determined at +20 °C and rated voltage. Here the series variance is taken into consideration. Variation max. ± 10 %.

Series- and parallel connection

It is possible to connect the sensors in series or parallel. When considering this it must be taken into account that the voltage drops are added for series connection and the residual voltages for parallel connection. Under these circumstances it is advisable to operate a maximum of three sensors in a corresponding circuit.

Frequency of operating cycles

The maximum damping and un-damping cycles of the proximity sensor within one second. To ascertain the frequency of operating cycles a pulse / break ratio of 1 : 2 is used as a basis.

Enclosure rating

IP 65: Protection against contact with voltage-carrying parts, protection against ingress of dust and water jet.

IP 67: Protection against contact with voltage-carrying parts, protection against ingress of dust and protection against ingress of water when the equipment is immersed in water, up to 1 m depths and for a period of 30 minutes.

Temperature variation

The displacement of the switching point if the ambient temperature changes. With MRS this is less than ± 10 %.

TECHNICAL TERMS

Modul

Diameter of a gearwheel in relation to the number of teeth. $M = D / T$

M = Modul

D = Diameter

T = Teeth

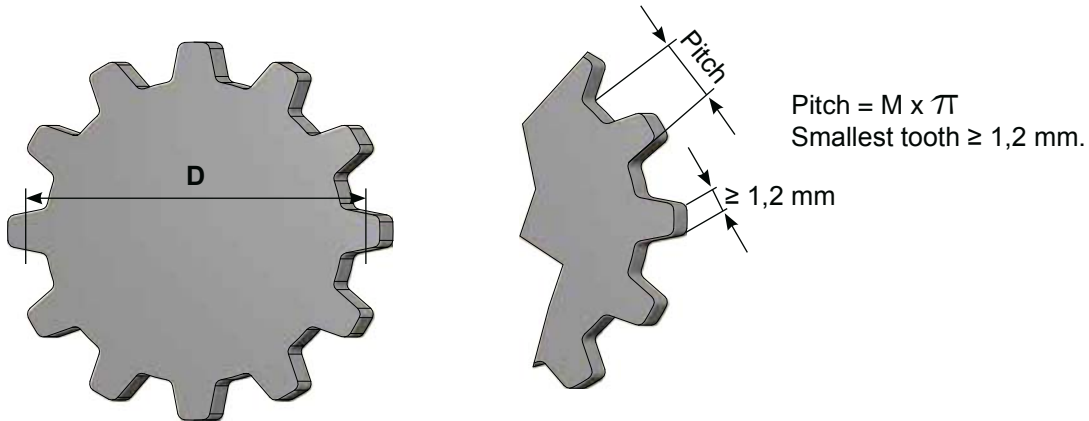

Maximum distance to the modul

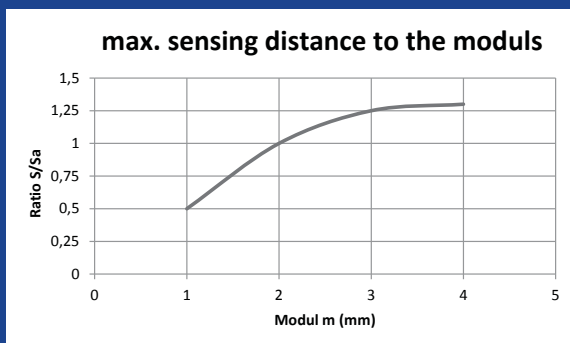

Reference modul: modul 2 mm

⇒ 100 % relation S/Sd

- Example 1: modul 1 mm
⇒ 50 % relation S/Sd (Sensing distance is halved)
- Example 2: modul 3 mm
⇒ 125 % relation S/Sd (Sensing distance increases by 1/4)

APPLICATION EXAMPLES

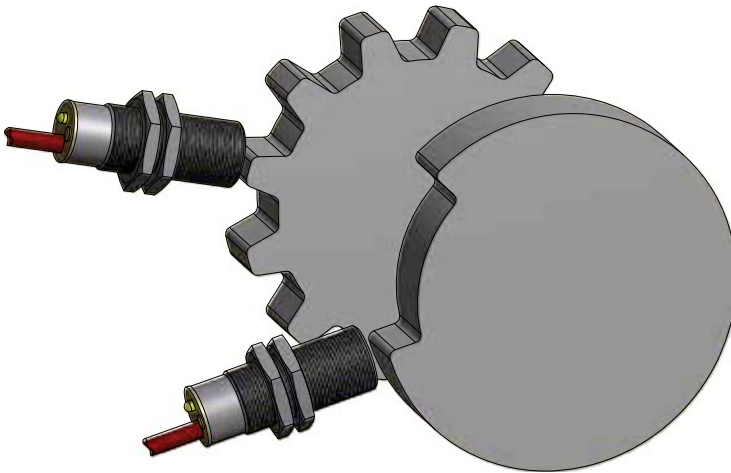

Switching frequency
0,5 up to 25 kHz

Magneto-resistive Sensors are ideal for the speed control of ferromagnetic gear wheels or cams. A big advantage is the high switching frequency from up to 25 kHz.

The application areas for magneto-resistive sensors are for instance:

- ✓ Detection of gear-wheels or cams.
- ✓ Speed or initial control
 - in machines, engines or gear boxes
 - in agricultural vehicles and machines
 - in forklift trucks
 - in construction machines and cranes
- ✓ Length measurement or position detection
 - in timber harvesting machines
- ✓ Lane position control of vehicles
 - by means of 2 teeth the position and correction is controlled
 - ✓ Detection of rotor revolution at prime mover
- ✓ Control of hydraulic pumps and hydraulic engines
 - in the field of fluid technology
- ✓ Replacement of encoders in certain applications where no reference pulse is required

Where there is limited space in an application, one MRS-350 - can replace 2 inductive sensors in applications where the rotary direction right/left is controlled, thanks to its ability to detect the direction of rotation.



TYPE CODE

Example:

MRS - 10 - 300 - S - M12 - VAa - Z02

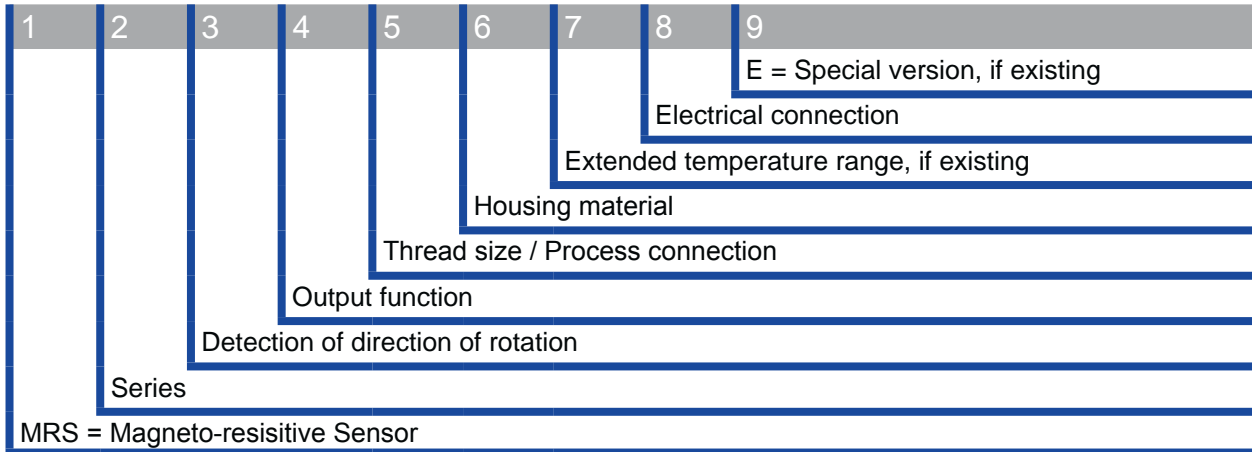

Position 2

Series	Output	Supply voltage
10	PNP	DC
20	NPN	DC
30	Namur	DC

Position 3

Value	Detection of direction of rotation	Cylindrical	Mounting
300	No	Yes	Flush
350	Yes	Yes	Flush

Position 4

Value	Output signal
S	Normally open (NO)
Ö	Normally closed (NC)
N	NAMUR
Z	Phase-shifted directional detection
OC	Open Collector

Position 5

Value	Thread size / Process connection
10	Ø 10 mm
M12	M 12 x 1
M18	M 18 x 1

All specifications are subject to change without notice. (20.02.2019)

TYPE CODE

Position 6

Material	Active zone	Housing
No indication	Plastic	Plastic
PA	Polyamide 6.6, fiberglass reinforced	Polyamide 6.6, fiberglass reinforced
PEEK	Polyetheretherketone FDA 21 CFR 177.2415	Polyetheretherketone FDA 21 CFR 177.2415
PP	Polypropylene	Polypropylene
PPO	Polyphenylene oxide	Polyphenylene oxide
VAb	Stainless steel No. 4305 / AISI 303 (AISI 303)	Stainless steel No. 4305 / AISI 303 (AISI 303)
VAc	Stainless steel No. 4305 / AISI 316L (AISI 316L)	Stainless steel No. 4305 / AISI 316L (AISI 316L)
MS	Brass	Brass

Position 7

Value	Extended temperature range
No indication	No extended temperature range
125C	125 °C

Position 8

Value	Electrical connection
No indication	Connection cable
Z0E	Special length of cable
Z01	Connection cable, 1 m
Z02	Connection cable, 2 m
Z05	Connection cable, 5 m
Z10	Connection cable, 10 m
Y3	Flange connector M 12 x 1 (Plastic), DC, 4 Pins
Y5	Flange connector M 12 x 1 (Metal), DC, 4 Pins

Position 9

Value	Special features
E	Special version

All specifications are subject to change without notice. (20.02.2019)



Magneto-resistive Sensors

Series 300 • 10 - PNP

Housing M 12 x 1

- Housing material: Stainless steel VA
- Magneto-resistive sensors detect ferromagnetic targets, such as gear wheels, wipers, slitting discs, gear rods, etc.
- Contactless detection of rotary motion, therefore wear-free and maintenance-free operation.
- Measuring range from 0 Hz up to 25 kHz. Ideal for the safe detection of creeping movements as well as fast rotary motions.
- Measuring gear wheel modul size 0.7...4.00
- Width of target gear wheel ≥ 10 mm

Technical data

Flush mountable

Operating sensing distance S_a < 2 mm (Modul 4), < 1 mm (Modul 1)

Electrical version 3-wire DC

Output Normally open

Type NPN

Art.-No.

Connection diagram No.

Type PNP

MRS-10-300-S-M12-VAb-Z02

Art.-No.

360 100

Connection diagram No. 4

Operating voltage (U_b) 10...35 V DC

Output current max. (I_o) 250 mA

Voltage drop max. (U_o) ≤ 2.5 V

Permitted residual ripple max. 10 %

No-load current (I_o) Typ. 15 mA

Frequency of operating cycles min. / max. 0.5 Hz / 25 kHz

Permitted ambient temperature $-40...+85$ °C / 125 °C*

LED-display Yellow

Protective circuit Built-in

Degree of protection IEC 60529 IP 67, IP 69K

Norm EN 60947-5-2

Connection cable 2 m, silicone, 3 x 0.34 mm²

Housing material VA No. 4305 / AISI 303

Active surface VA No. 4305 / AISI 303

Lid PEEK (FDA 21 CFR 177.2415)

All specifications are subject to change without notice. (20.02.2019)

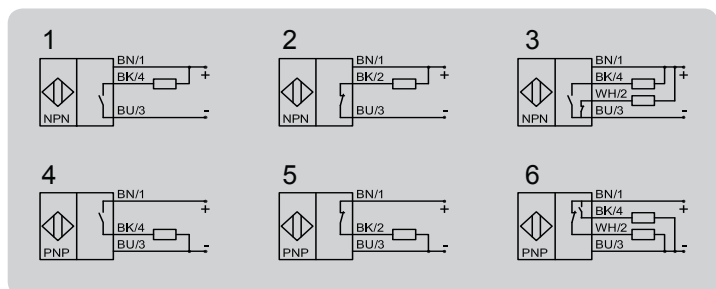
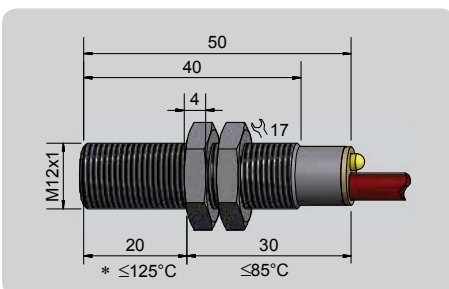

Made in Germany



Magneto-resistive Sensors Series 300 • 10 - PNP

Housing M 12 x 1

- Housing material: PA
- Magneto-resistive sensors detect ferromagnetic targets, such as gear wheels, wipers, slitting discs, gear rods, etc.
- Contactless detection of rotary motion, therefore wear-free and maintenance-free operation.
- Measuring range from 0 Hz up to 25 kHz. Ideal for the safe detection of creeping movements as well as fast rotary motions.
- Measuring gear wheel modul size 0.7...4.00
- Width of target gear wheel ≥ 10 mm

Technical data

Operating sensing distance S_a	Flush mountable < 2 mm (Modul 4), < 1 mm (Modul 1)
Electrical version	3-wire DC
Output	Normally open
Type NPN	
Art.-No.	
Connection diagram No.	
Type PNP	
MRS-10-300-S-M12-PA-Z02	
Art.-No.	
360 150	
Connection diagram No.	
4	
Operating voltage (U_B)	10...35 V DC
Output current max. (I_e)	250 mA
Voltage drop max. (U_o)	≤ 2.5 V
Permitted residual ripple max.	10 %
No-load current (I_o)	Typ. 15 mA
Frequency of operating cycles min. / max.	0.5 Hz / 25 kHz
Permitted ambient temperature	-25...+70 °C
LED-display	Yellow
Protective circuit	Built-in
Degree of protection IEC 60529	IP 67
Norm	EN 60947-5-2
Connection cable	2 m, PUR, 3 x 0.14 mm ²
Housing material	PA
Active surface	PA
Lid	PA

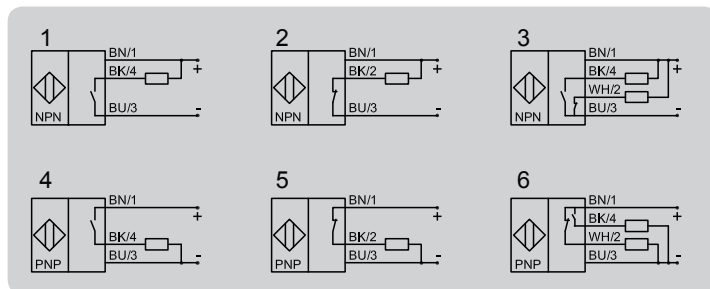
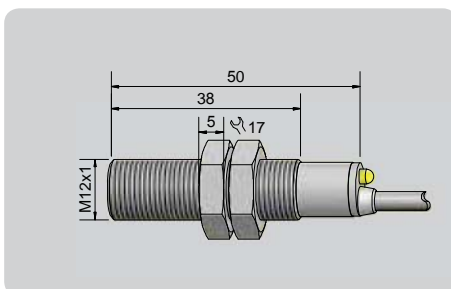

Made in Germany

All specifications are subject to change without notice. (20.02.2019)



Magneto-resistive Sensors Series 300 • 10 - PNP

Housing M 12 x 1

- Housing material: Stainless steel VA
- Magneto-resistive sensors detect ferromagnetic targets, such as gear wheels, wipers, slitting discs, gear rods, etc.
- Contactless detection of rotary motion, therefore wear-free and maintenance-free operation.
- Measuring range from 0 Hz up to 25 kHz. Ideal for the safe detection of creeping movements as well as fast rotary motions.
- Measuring gear wheel modul size 0.7...4.00
- Width of target gear wheel ≥ 10 mm
- With flange connector M 12 x 1

Technical data

Operating sensing distance S_a	Flush mountable < 2 mm (Modul 4), < 1 mm (Modul 1)
Electrical version	3-pin DC
Output	Normally open
Type NPN	
Art.-No.	
Connection diagram No.	
Type PNP	MRS-10-300-S-M12-VAb-Y5
Art.-No.	360 180
Connection diagram No.	4
Operating voltage (U_b)	10...35 V DC
Output current max. (I_o)	250 mA
Voltage drop max. (U_o)	≤ 2.5 V
Permitted residual ripple max.	10 %
No-load current (I_o)	Typ. 10 mA
Frequency of operating cycles min. / max.	0,5 Hz / 25 kHz
Permitted ambient temperature	-40...+85 °C / 125 °C*
LED-display	-
Protective circuit	Built-in
Degree of protection IEC 60529	IP 67, IP 69K
Norm	EN 60947-5-2
Connection	Flange connector M 12 x 1
Housing material	Va No. 4305 / AISI 303
Active surface	VA No. 4305 / AISI 303
Lid	-

All specifications are subject to change without notice. (20.02.2019)

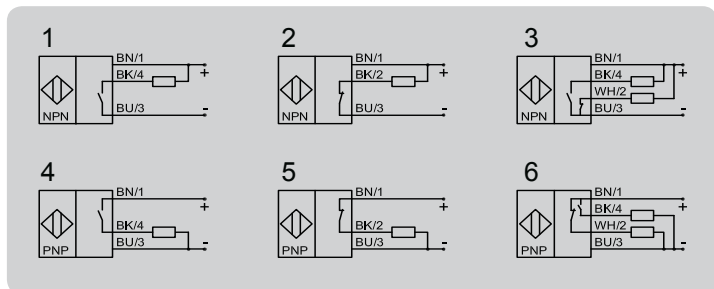
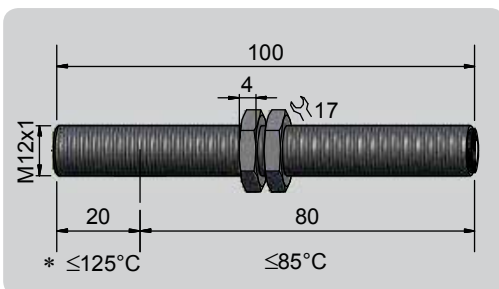

Made in Germany



Magneto-resistive Sensors Series 300 • 2-wire

Housing M 12 x 1

- Housing material: PA
- Magneto-resistive sensors detect ferromagnetic targets, such as gear wheels, wipers, slitting discs, gear rods, etc.
- Contactless detection of rotary motion, therefore wear-free and maintenance-free operation.
- Measuring range from 0 Hz up to 25 kHz. Ideal for the safe detection of creeping movements as well as fast rotary motions.
- Measuring gear wheel modul size 0.7...4.00
- Width of target gear wheel ≥ 10 mm

Technical data	Flush mountable
Operating sensing distance S_a	< 2 mm (Modul 4), < 1 mm (Modul 1)
Electrical version	2-wire DC
Output	Normally open
Type	MRS-30-300-N-M12-PA-Z02
Art.-No.	362 100
Operating voltage (U_B)	7.5...20 V DC
Output current active surface free	Typ. 7 mA
Output current active surface covered	Typ. 14 mA
Self-inductance (L)	100 μ H
Self-capacitance (C)	500 pF
Voltage drop max. (U_d)	≤ 2.5 V
Permitted residual ripple max.	10 %
No-load current (I_0)	Typ. 7 mA
Frequency of operating cycles min. / max.	0.5 Hz / 25 kHz
Permitted ambient temperature	-25...+70 °C
LED-display	-
Protective circuit	Built-in
Degree of protection IEC 60529	IP 67
Norm	EN 60947-5-2
Connection cable	2 m, PVC, 2 x 0.14 mm ²
Housing material	PA
Active surface	PA
Lid	PA

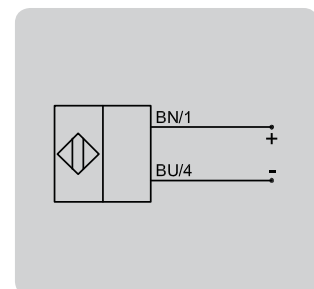
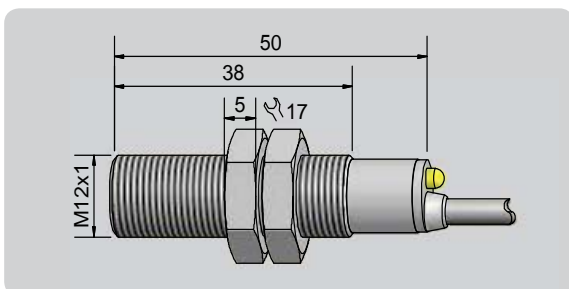

Made in Germany

All specifications are subject to change without notice. (20.02.2019)



Magneto-resistive Sensors Series 300 • 10 - PNP

Housing M 18 x 1

- Housing material: Stainless steel VA
- Magneto-resistive sensors detect ferromagnetic targets, such as gear wheels, wipers, slitting discs, gear rods, etc.
- Contactless detection of rotary motion, therefore wear-free and maintenance-free operation.
- Measuring range from 0 Hz up to 25 kHz. Ideal for the safe detection of creeping movements as well as fast rotary motions.
- Measuring gear wheel modul size 0.7...4.00
- Width of target gear wheel ≥ 10 mm

Technical data

	Flush mountable
Operating sensing distance S_a	< 4 mm (Modul 4), < 2 mm (Modul 1)
Electrical version	3-wire DC
Output	Normally open
Type NPN	
Art.-No.	
Connection diagram No.	
Type PNP	
MRS-10-300-S-M18-VAc-Z02	
Art.-No.	
360 500	
Connection diagram No.	
4	
Operating voltage (U_b)	10...35 V DC
Output current max. (I_o)	250 mA
Voltage drop max. (U_o)	≤ 2.5 V
Permitted residual ripple max.	10 %
No-load current (I_o)	Typ. 15 mA
Frequency of operating cycles min. / max.	0.5 Hz / 25 kHz
Permitted ambient temperature	$-40...+85$ °C / 125 °C*
LED-display	Yellow
Protective circuit	Built-in
Degree of protection IEC 60529	IP 67, IP 69K
Norm	EN 60947-5-2
Connection cable	2 m, silicone, 3 x 0.34 mm ²
Housing material	VA No. 4305 / AISI 316L
Active surface	VA No. 4305 / AISI 316L
Lid	PEEK (FDA 21 CFR 177.2415)

All specifications are subject to change without notice. (20.02.2019)

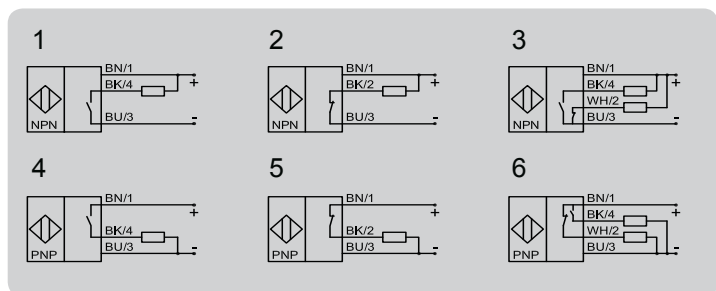
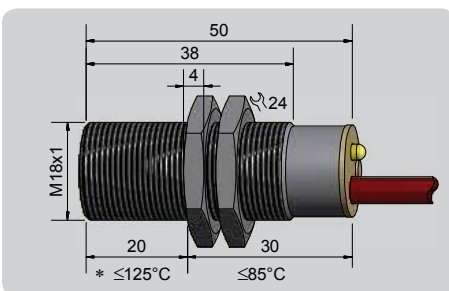

Made in Germany



Magneto-resistive Sensors with detection of direction of rotation Series 350 • 10 - PNP

Housing M 12 x 1

- Housing material: Stainless steel VA
- Magneto-resistive sensors detect ferromagnetic targets, such as gear wheels, wipers, slitting discs, gear rods, etc.
- Contactless detection of rotary motion, therefore wear-free and maintenance-free operation.
- Measuring range from 0 Hz up to 25 kHz. Ideal for the safe detection of creeping movements as well as fast rotary motions.
- Measuring gear wheel modul size 0.7...4.00
- Width of target gear wheel ≥ 10 mm

Technical data

	Flush mountable
Operating sensing distance S_a	< 2 mm (Modul 4), < 1 mm (Modul 1)
Electrical version	4-wire DC
Output	Normally open
Type NPN	
Art.-No.	
Connection diagram No.	
Type PNP	
MRS-10-350-S-M12-VAb-Z02	
Art.-No.	
360 900	
Connection diagram No.	
2	
Operating voltage (U_B)	10...35 V DC
Output current max. (I_o)	250 mA
Voltage drop max. (U_o)	≤ 2.5 V
Permitted residual ripple max.	10 %
No-load current (I_o)	Typ. 15 mA
Frequency of operating cycles min. / max.	0.5 Hz / 25 kHz
Permitted ambient temperature	$-40...+85$ °C / 125 °C*
LED-display	Green / yellow
Protective circuit	Built-in
Degree of protection IEC 60529	IP 67, IP 69K
Norm	EN 60947-5-2
Connection cable	2 m, silicone, 4 x 0.14 mm ²
Housing material	VA No. 4305 / AISI 303
Active surface	VA No. 4305 / AISI 303
Lid	PEEK (FDA 21 CFR 177.2415)

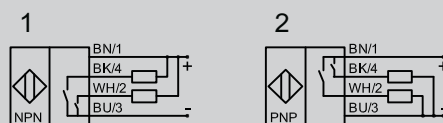
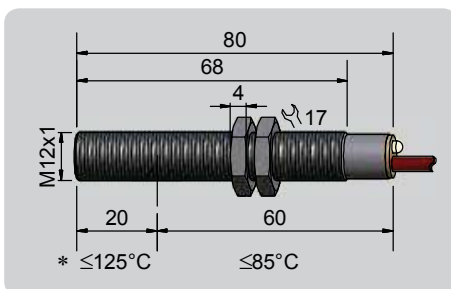

BK = Speed control
WH = detection of direction of rotation

Made in Germany

All specifications are subject to change without notice. (20.02.2019)



Magneto-resistive Sensors with detection of direction of rotation Series 350 • 10 - PNP

Housing M 18 x 1

- Housing material: Stainless steel VA
- Magneto-resistive sensors detect ferromagnetic targets, such as gear wheels, wipers, slitting discs, gear rods, etc.
- Contactless detection of rotary motion, therefore wear-free and maintenance-free operation.
- Measuring range from 0 Hz up to 25 kHz. Ideal for the safe detection of creeping movements as well as fast rotary motions.
- Measuring gear wheel modul size 0.7...4.00
- Width of target gear wheel ≥ 10 mm

Technical data

Flush mountable

Operating sensing distance S_a < 4 mm (Modul 4), < 2 mm (Modul 1)

Electrical version 4-wire DC

Output Normally open

Type NPN

Art.-No.

Connection diagram No.

Type PNP

MRS-10-350-S-M18-VAc-Z02

Art.-No.

361 300

Connection diagram No. 2

Operating voltage (U_b) 10...35 V DC

Output current max. (I_o) 2 x 250 mA

Voltage drop max. (U_o) ≤ 2.5 V

Permitted residual ripple max. 10 %

No-load current (I_o) Typ. 15 mA

Frequency of operating cycles min. / max. 0.5 Hz / 25 kHz

Permitted ambient temperature -40...+85 °C / 125 °C*

LED-display Green / yellow

Protective circuit Built-in

Degree of protection IEC 60529 IP 67, IP 69K

Norm EN 60947-5-2

Connection cable 2 m, silicone, 4 x 0.34 mm²

Housing material VA No. 4305 / AISI 316L

Active surface VA No. 4305 / AISI 316L

Lid PEEK (FDA 21 CFR 177.2415)

All specifications are subject to change without notice. (20.02.2019)

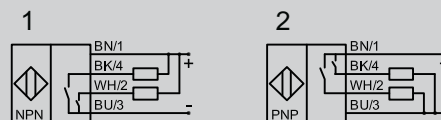
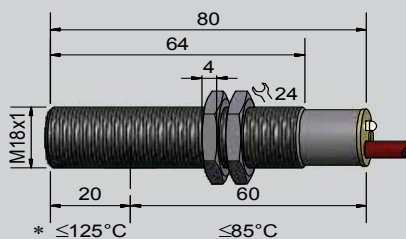

BK = Speed control
WH = detection of direction of rotation

Made in Germany



Magneto-resistive Sensors with detection of direction of rotation Series 350 • 10 - PNP

Housing M 12 x 1

- Housing material: Stainless steel VA
- Magneto-resistive sensors detect ferromagnetic targets, such as gear wheels, wipers, slitting discs, gear rods, etc.
- Contactless detection of rotary motion, therefore wear-free and maintenance-free operation.
- Measuring range from 0 Hz up to 25 kHz. Ideal for the safe detection of creeping movements as well as fast rotary motions.
- Measuring gear wheel modul size 0.7...4.00
- Width of target gear wheel ≥ 10 mm
- Determination of direction is possible by analysing the 45° phase shift between the two output channels of the sensor.
- With dephased output signal

Technical data	Flush mountable
Operating sensing distance S_a	< 2 mm (Modul 4), < 1 mm (Modul 1)
Electrical version	4-wire DC
Output	Normally open
Type PNP	MRS-10-350-Z-M12-VAb-Z02
Art.-No.	360 950
Connection diagram No.	2
Operating voltage (U_B)	10...35 V DC
Output current max. (I_o)	2 x 250 mA
Voltage drop max. (U_o)	≤ 2.5 V
Permitted residual ripple max.	10 %
No-load current (I_o)	Typ. 15 mA
Frequency of operating cycles min. / max.	0.5 Hz / 25 kHz
Permitted ambient temperature	-40...+85 °C / 125 °C*
LED-display	Green / yellow
Protective circuit	Built-in
Degree of protection IEC 60529	IP 67, IP 69K
Norm	EN 60947-5-2
Connection cable	2 m, silicone, 4 x 0.14 mm ²
Housing material	VA No. 4305 / AISI 303
Active surface	VA No. 4305 / AISI 303
Lid	PEEK (FDA 21 CFR 177.2415)

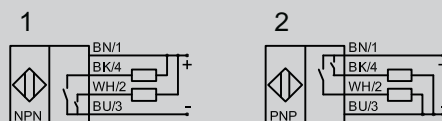
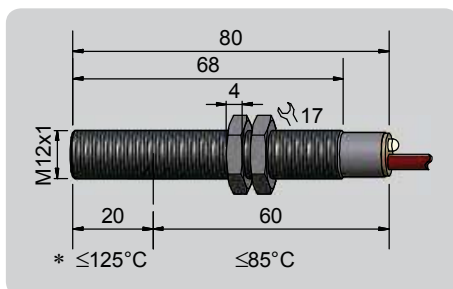

BK = Speed control
WH = detection of direction of rotation dephased

Made in Germany

All specifications are subject to change without notice. (20.02.2019)



Magneto-resistive Sensors with detection of direction of rotation Series 350 • 10 - PNP

Housing M 18 x 1

- Housing material: Stainless steel VA
- Magneto-resistive sensors detect ferromagnetic targets, such as gear wheels, wipers, slitting discs, gear rods, etc.
- Contactless detection of rotary motion, therefore wear-free and maintenance-free operation.
- Measuring range from 0 Hz up to 25 kHz. Ideal for the safe detection of creeping movements as well as fast rotary motions.
- Measuring gear wheel modul size 0.7...4.00
- Width of target gear wheel ≥ 10 mm
- Determination of direction is possible by analysing the 45° phase shift between the two output channels of the sensor.
- With dephased output signal

Technical data

Operating sensing distance S_a	Flush mountable < 4 mm (Modul 4), < 2 mm (Modul 1)
Electrical version	4-wire DC
Output	Normally open
Type PNP	MRS-10-350-Z-M18-VAc-Z02
Art.-No.	361 430
Connection diagram No.	2
Operating voltage (U_b)	10...35 V DC
Output current max. (I_o)	250 mA
Voltage drop max. (U_d)	≤ 2.5 V
Permitted residual ripple max.	10 %
No-load current (I_o)	Typ. 15 mA
Frequency of operating cycles min. / max.	0.5 Hz / 25 kHz
Permitted ambient temperature	-40...+85 °C / 125 °C*
LED-display	Green / yellow
Protective circuit	Built-in
Degree of protection IEC 60529	IP 67, IP 69K
Norm	EN 60947-5-2
Connection cable	2 m, silicone, 4 x 0.34 mm ²
Housing material	VA No. 4305 / AISI 316L
Active surface	VA No. 4305 / AISI 316L
Lid	PEEK (FDA 21 CFR 177.2415)

All specifications are subject to change without notice. (20.02.2019)

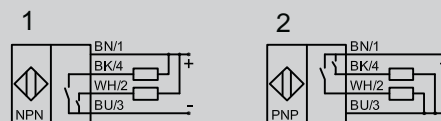
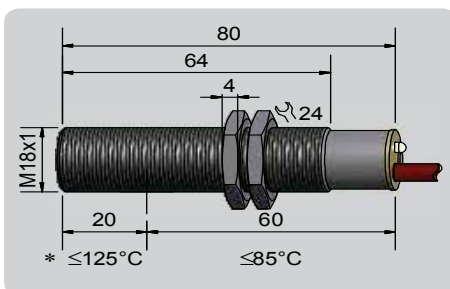

BK = Speed control
WH = detection of direction of rotation dephased

Made in Germany

NORMS

The products of Rechner Industrie-Elektronik GmbH are designed and checked in accordance with the standards and specifications, DIN - VDE - IEC, for electric and electronic instruments. For new and revised products the newest standards are always used.

Effective standards for proximity switches and sensors:

IEC 947-5-2 Low-voltage switchgear and controlgear
Control circuit devices and switching elements - proximity switches

EN 60947-5-6 Low-voltage switchgear and controlgear Part 5
Control circuit devices and switching elements, proximity sensors - DC interface for proximity sensors and switching amplifiers (NAMUR)

International Standards

IEC 947-5-2 Low-voltage switchgear and controlgear Part 5
Control circuit devices and switching elements - Section 2, proximity switches

Draft IEC 61934
Control circuit devices and switching elements DC interface for proximity sensors and switching amplifiers (NAMUR)

Standards On Explosion Protection

DIN EN 60079-0
Explosive atmospheres - Part 0: Equipment - General requirements

DIN EN 60079-10
Explosive atmospheres - Part 10-1: Classification of areas - Explosive gas atmospheres

DIN EN 60079-11
Explosive atmospheres - Part 11: Equipment protection by intrinsic safety „i“

DIN EN 60079-15
Electrical apparatus for potentially explosive gas atmospheres - Part 15: construction, test and marking of type of protection “n” electrical apparatus

DIN EN 60079-18
Electrical apparatus for potentially explosive gas atmospheres - Part 18: Construction, test and marking of type of protection encapsulation “m” electrical apparatus

EN 60079-14
Electrical apparatus for potentially explosive gas environments.
Classification of hazardous areas (mines excepted).

Norms for quality assurance (QS)

DIN ISO 9000-9004 (EN 29000-29 004)
Quality assurance (QA) for products and services

NORMS

DIN ISO 9001

Quality assurance in design/development, production, installation and servicing

DIN ISO 9002

Quality assurance in production

DIN ISO 9003

Quality assurance for final testing only

DIN ISO 9004

Quality management and elements of a quality management system

RECHNER Industrie-Elektronik-GmbH is certified according to DIN ISO 9001:2008.

- Marking

The CE marking represents the manufacturer's confirmation that the identified product conforms to applicable standards and directives throughout Europe.

The following regulations apply to the RECHNER products.

2014/30/EU

EMC Directive (EN 60 947-5-2)

2014/35/EU

Low-voltage Directive (compare with VDE 0160, product standard EN 60947-5-2)

Directive 2014/34/EU

Equipment and Protection Systems designed for use in potentially explosive environments

RECHNER Industrie-Elektronik GmbH certifies the conformity of its products with each of the applicable directives in a Manufacturer's Declaration.

TYPE SELECTION IN ARTICLE NUMBER ORDER			TYPE SELECTION IN DESCRIPTION ORDER		
Art.-No.	Type Description	Page	Type Description	Art.-No.	Page
360100	MRS-10-300-S-M12-VAb-Z02	13	MRS-10-300-S-M12-VAb-Z02	360100	13
360150	MRS-10-300-S-M12-PA-Z02	14	MRS-10-300-S-M12-PA-Z02	360150	14
360180	MRS-10-300-S-M12-VAb-Y5	15	MRS-10-300-S-M12-VAb-Y5	360180	15
360500	MRS-10-300-S-M18-VAc-Z02	17	MRS-30-300-N-M12-PA-Z02	362100	16
360900	MRS-10-350-S-M12-VAb-Z02	18	MRS-10-300-S-M18-VAc-Z02	360500	17
360950	MRS-10-350-Z-M12-VAb-Z02	20	MRS-10-350-S-M12-VAb-Z02	360900	18
361300	MRS-10-350-S-M18-VAc-Z02	19	MRS-10-350-Z-M12-VAb-Z02	360950	20
361430	MRS-10-350-Z-M18-VAc-Z02	21	MRS-10-350-S-M18-VAc-Z02	361300	19
362100	MRS-30-300-N-M12-PA-Z02	16	MRS-10-350-Z-M18-VAc-Z02	361430	21

Customer proximity guaranteed!

Rechner Sensors has daughter and sister companies in China, Great Britain, Italy, Canada, South Korea and in the U.S..

Furthermore we have representative offices in over 50 countries. For the addresses of our sales partners please visit our website. You will find the addresses under the category contact.

CANADA

Rechner Automation Inc
348 Bronte St. South - Unit 11
Milton, ON L9T 5B6

Tel. 905 636 0866
Fax. 905 636 0867
contact@rechner.com
www.rechner.com

GREAT BRITAIN

Rechner (UK) Limited
Unit 6, The Old Mill
61 Reading Road
Pangbourne, Berks, RG8 7HY

Tel. +44 118 976 6450
Fax. +44 118 976 6451
info@rechner-sensors.co.uk
www.rechner-sensors.co.uk

ITALY

Rechner Italia SRL
Via Isarco 3
39100 Bolzano (BZ)
Office:
Via Dell'Arcoveggio 49/5
40129 Bologna
Tel. +39 051 0015498
Fax. +39 051 0015497
vendite@rechneritalia.it
www.rechneritalia.it

PEOPLE'S REPUBLIC OF CHINA

RECHNER SENSORS SIP CO.LTD.
Building H,
No. 58, Yang Dong Road
Suzhou Industrial Park
Jiangsu Province

Tel. +8651267242858
Fax. +8651267242868
assist@rechner-sensor.cn
www.rechner-sensor.cn

REPUBLIC OF KOREA (SOUTH)

Rechner-Korea Co. Ltd.
A-1408 Ho,
Keumgang Penterium IT Tower,
Hakeuro 282, Dongan-gu
Anyang City, Gyunggi-do, Seoul

Tel. +82 31 422 8331
Fax. +82 31 423 83371
sensor@rechner.co.kr
www.rechner.co.kr

UNITED STATES OF AMERICA

Rechner Electronics Ind. Inc.
6311 Inducon Corporate Drive,
Suite 5
Sanborn, NY. 14132

Tel. 800 544 4106
Fax. 905 636 0867
contact@rechner.com
www.rechner.com



All specifications are subject to change without notice. (20.02.2019)

RECHNER

INDUSTRIE-ELEKTRONIK GMBH

Gaußstraße 6-10 • 68623 Lampertheim • Germany

T: +49 6206 5007-0 • F: +49 6206 5007-36 • F Intl. +49 6206 5007-20

www.rechner-sensors.com • E-mail: info@rechner-sensors.de