



## Capacitive Sensors

### Series 80 - PNP



Housing M 32 x 1.5

- Housing material: PTFE
- Ideal for detection of chemically aggressive media
- Ideal for use in food applications
- Sensing distance 0,5...30 mm adjustable
- Option: Total chemical resistance is given when ordering the sensor with PTFE cable and PTFE - protection set Art.-No. 196301

Certificate:



Technical data	Flush mountable
Operating distance $S_n$	20 mm
Operating distance min. / max. adjustable	0.5...30 mm
Electrical version	4-wire DC
Output	Antivalent (NO + NC)
<b>Type NPN</b>	
<b>Art.-No.</b>	
Connection diagram No.	
<b>Type PNP</b>	
<b>KAS-80-30-A-K-M32-PTFE</b>	
<b>Art.-No.</b>	
<b>KA 0179</b>	
Connection diagram No.	
6	
Operating voltage ( $U_B$ )	
10...35 V DC	
Output current max. ( $I_o$ )	
2 x 250 mA	
Voltage drop max. ( $U_d$ )	
≤ 2.0 V	
Permitted residual ripple max.	
10 %	
No-load current ( $I_o$ )	
Typ. 15 mA	
Frequency of operating cycles max.	
200 Hz	
Permitted ambient temperature	
-25...+70 °C	
LED-display	
Yellow / green	
Protective circuit	
Built-in	
Degree of protection IEC 60529	
IP 67	
Norm	
EN 60947-5-2	
Connection cable	
5 m, PVC, 4 x 0.5 mm <sup>2</sup>	
Housing material	
PTFE (FDA 21 CFR 177.1550)	
Active surface	
PTFE (FDA 21 CFR 177.1550)	
Lid	
PA / PPO	

All specifications are subject to change without notice. (05.04.2016)

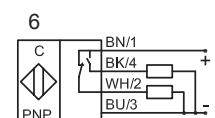
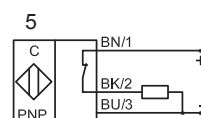
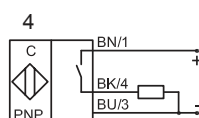
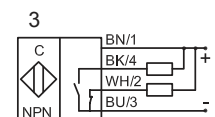
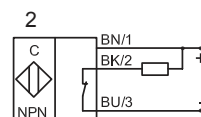
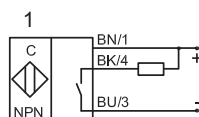
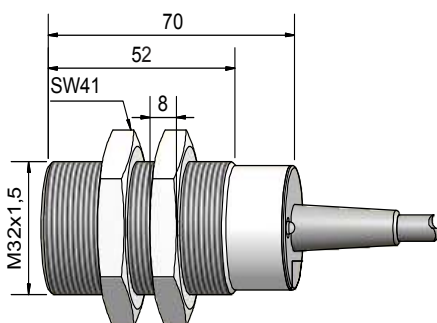

**Made in Germany**