



**Capacitive Sensors**  
**Series 70 - NPN**  
**Series 80 - PNP**



Housing M 12 x 1

- Housing material: Stainless steel VA
- Sensing distance 0.5...5 mm adjustable
- With flange connector M 12 x 1

Certificate:



**Technical data**

Operating distance $S_n$	Flush mountable 2 mm
Operating distance min. / max. adjustable	0.5...5 mm
Electrical version	4-pin DC
Output	Antivalent (NO + NC)
<b>Type NPN</b>	<b>KAS-70-A12-A-Y5-NL</b>
Art.-No.	KA 0710
Connection diagram No.	3
<b>Type PNP</b>	<b>KAS-80-A12-A-Y5-NL</b>
Art.-No.	KA 0670
Connection diagram No.	6
Operating voltage ( $U_B$ )	12...30 V DC
Output current max. ( $I_o$ )	2 x 200 mA
Load current min.	-
Voltage drop max. ( $U_d$ )	≤ 2.0 V
Permitted residual ripple max.	5 %
No-load current ( $I_o$ )	< 15 mA
Frequency of operating cycles max.	300 Hz
Permitted ambient temperature	-25...+70 °C
LED-display	Yellow
Protective circuit	Built-in
Degree of protection IEC 60529	IP 67
Norm	EN 60947-5-2
Connection	Flange connector M 12 x 1
Housing material	VA Nr. 1.4305
Active surface	PA / PPO
Lid	-

All specifications are subject to change without notice. (28.01.2010)

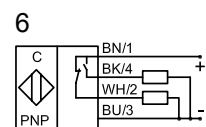
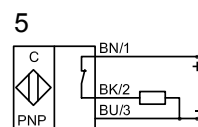
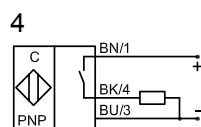
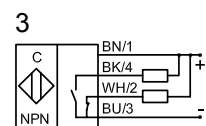
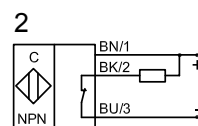
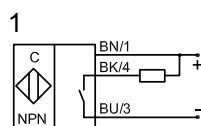
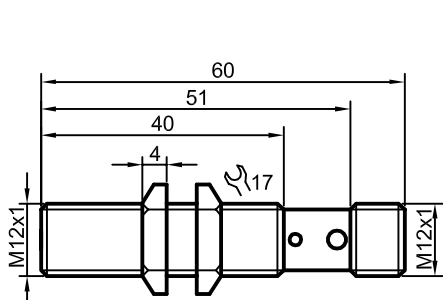

**Made in Germany**